



Dental Sensor

Guilin Refine Medical Instrument Co., LTD.
RF-DSS-M001 Edition: V1.0 Modify: 20211202

Catalogue

1 Preface	1
2 Spare parts	3
3 Signs and notices	4
4 Installation and operation	5
5 Software introduction	8
6 Trouble shooting	15
7 Cleaning, disinfection	16
8 Storage and transportation	16
9 After-sales service	17
10 Electromagnetic compatibility	17
11 Statement	19

1 Preface

Before operating, properly read this user manual and pay attention to all safety precautions.

Please ensure that this user's manual is properly maintained so that it can be accessed at any time.

Please use it correctly on the basis of full understanding of the content.

1.1 Application scope

R1 and R2 dental sensor are used in conjunction with dental radiography in medical units. The product is used for dental X-ray examination, the diagnosis of structural diseases of teeth, jaws and mouth. The product is expected to be used in hospitals and clinics, operated and used by trained professionals under the guidance of doctors.

According to the expected use of R1/R2 and the result of risk assessment, the product essential performance is identified: image acquisition of X-ray sensor and image process.

This manual contains information about R1/R2. All users should read and understand this manual before using the product. All information in this manual, including illustrations, is based on the device prototype. If the device does not contain these contents, they will not apply to this device.

1.2 Safety precautions

1.2.1 Do not use or store the equipment near flammable chemicals such as thinner, benzene, etc.

If chemicals are spilled or evaporate, it may result in fire or product damage through contact with electric parts inside the equipment.

Do not connect the equipment with anything other than specified. Doing so may result in personal injury or product damage.

Do not install or use in the following environment, or it may cause fire, personal injury or product damage.

- Facilities near water sources
- In direct sunlight
- Close to air condition or ventilation Dusty to a heat source as a heater
- In a salty or acidic environment High temperature and high humidity Ice or condensation
- In the environment easy to vibrate On a slope or in an unstable area

1.2.2 Ensure that the cable is not knotted or wound during use. Or it may cause the equipment damage or personal injury.

1.2.3 Never disassemble or modify the equipment. No modification of this equipment is allowed.

1.2.4 Follow the below instructions to prevent damage to the sensor and cable:

- Do not twist, bend, pull and pinch the cable strongly
- Do not strike or drop the equipment.

- Do not touch the pin of the USB connector
- Do not put the equipment and pointed objects together.

1.2.5 Please unplug the USB connector when a problem happened and contact the supplier or local dealer:

- When there is smoke, an odd smell or abnormal sound.
- When liquid has been spilled into the equipment or a metal object has entered through an opening.
- When the equipment has been dropped and damaged.

1.3 Notes for Using

When using the equipment, take the following precautions. Otherwise, problems may occur and the equipment may not function correctly.

Before using

- Please check whether the USB connector is dry or clean before connecting the USB connector
- Please hold the control box of the USB when plugging the USB connector, do not touch the pin of USB connector

During using

- Do not move the USB connector during the use of the sensor
- When the sensor is working, the temperature of the sensor will increase. Please pay attention to the temperature of the sensor to avoid the risk of injury.
- The detector should warm up for 15 minutes before exposure or updating the gain map or defect map.

During exposure

- Do not move the Cable or Sensor during exposure, or it may cause image noise or artifacts, even incorrect images.
- Do not use the devices near the equipment generating a strong magnetic field. Otherwise, it may cause image noise, artifacts or even incorrect images.

After using







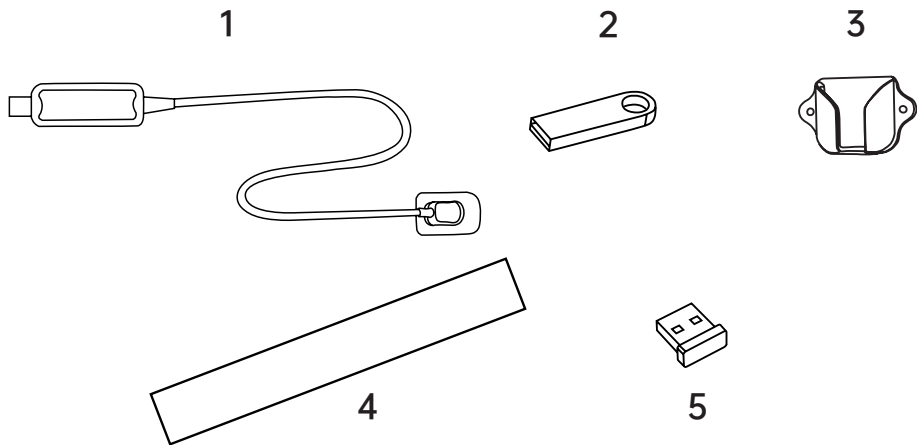



- After the USB port is pulled out, please take care of the USB connector to avoid the risk of damage.
- The sensor should be stored in a place free of chemicals or gases and free from adverse factors such as pressure, high temperature, humidity, direct sunlight, dust, oxides or sulfides.

2 Spare parts

1. Sensor
2. USB flash disk (Software)
3. Sensor holder
4. Protective sleeve
5. Dongle



3 Symbol instruction



Symbol	Instruction	Symbol	Instruction
	Date of manufacture		Manufacturer
	Serial number		Type BF applied part
	Keep dry		Temperature limit: -20°C- +40°C
	Humidity limitation: 10%-93%		Atmospheric pressure limitation: 70kPa-106kPa
	Recovery		Waste electrical and electronic equipment

4 Installation and operation

4.1 Hardware and software requirement

Processor	1.0GHz or above
Memory	2GB or above
Hard disk	64GB or above
Display resolution	1024*768 or above
USB port	USB2.0
Operating system	Windows 7 or above

4.2 Installation

<p>Step 1: Plug in the USB flash disk, then double click the "run" file</p>	
<p>Step 2: Click "Next" to start installation</p>	

Step 3: Select the installation location, click "Review" to change the installation location or directly click "Next" to continue

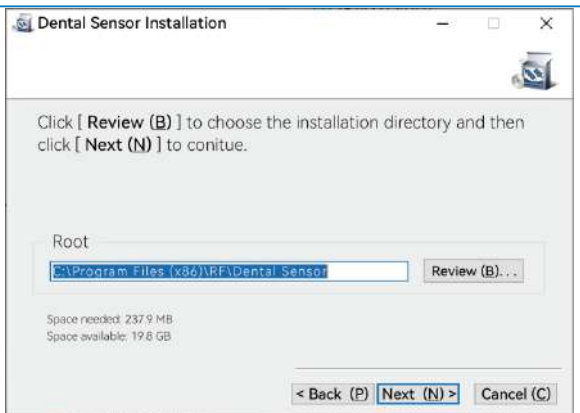

Step 4: If there's only one device, you may select "Single-User" installation. If the sensor is connected to multiple device, select "Host" for the device connected with the sensor and other devices select "Extension" to install, then click Next to continue

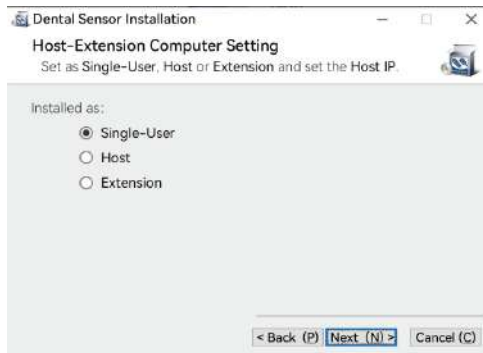

Step 5: Plug in the sensor and the dongle, then click "Finish" to finalize the installation

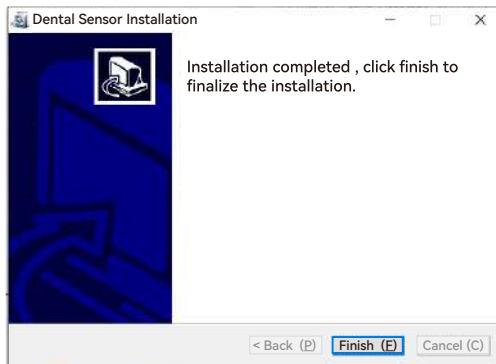

Note 1: When choosing the "Extension", you need to enter the IP address of the host computer, and then click "Next" to continue.

Note 2: The dongle should always be connected to the device when using the sensor, otherwise you can only shoot 50 images.

4.3 Fix the sensor holder on the right place



5 Software introduction









5.1 Input User and Password, then click confirm to start the software:



























USER	user
Password	Default password: 123456

5.2 Pages introduction

5.2.1 Operating page

The screenshot shows a software interface for dental radiography. The main area displays a large X-ray image of a tooth. The interface is annotated with red circles and numbers 1 through 38, corresponding to the legend below. The legend is organized into two columns of two rows each.

①	 Logo	②	 Patient management
③	 New patient	④	 Exposure
⑤	 Save	⑥	 Image export: Image can be DCM, JPG or PNG format

⑦ 	Image import: Image can be DCM, JPG or PNG format	⑧ 	Image delete
⑨ 	Report print: Prints a report of the current patient	⑩ 	Full screen
⑪ 	View: To view or compare 2 or 4 images at the same time	⑫ 	Setting
⑬	Patent's name	⑭	Image list
⑮	Image checking	⑯	Teeth Position
⑰ 	Contrast	⑱ 	Brightness
⑲ 	Gamma	⑳ 	Negative: Image show the effect of the negative
㉑ 	Denoising: Remove spots on the image	㉒ 	Sharpen: Highlight the edge of the image
㉓ 	Pseudocolor	㉔ 	Periodontal: More clearly to check the decayed teeth
㉕ 	Crown: More clearly to observe the crown	㉖ 	Endodontic: More clearly to observe the root
㉗ 	Rotate 90°clockwise	㉘ 	Flip horizontally
㉙ 	Flip vertically	㉚ 	Zoom up
㉛ 	Distance: Measure the length between any two points on the image	㉜ 	Angle: Select three points on the image to measure the angle between the three points
㉝ 	Pencil	㉞ 	Revert
㉟ 	Undo	㉟ 	Redo
㊱ 	Edit	㊲ 	Save

5.2.2 Patients management

The screenshot shows a window titled "Patient Management" with a search bar and a "Delete all" button. Below is a table with columns: Surname, First name, Patient No., Dentist, Gender, Date of Birth, and Phone. One row is visible with the following data: Surname: 秦, First name: 雯雯, Patient No.: (empty), Dentist: 卢仁靖, Gender: Male, Date of Birth: 10/29/2021, Phone: (empty). To the right of the table is a form with fields for Surname, First name, PatientNo., Dentist, Date of Birth, Gender, Phone, Email, Address, Post Code, and Remark. At the bottom are three buttons: "New Patient", "Edit Patient", and "Delete Patient".

Surname	First name	Patient No.	Dentist	Gender	Date of Birth	Phone
秦	雯雯		卢仁靖	Male	10/29/2021	

Create a new patient or select a patient

The screenshot shows a window titled "New Patient" with two sections: "Personal information" and "File information".

Personal information

Surname: Date of Birth: 11/16/2021
First name: Gender:

File information

Patient No.: Phone:
Dentist: Email:
Remark: Post Code:
Address:

At the bottom right are "Ok" and "Cancel" buttons.

New Patient

After creating a new patient or select a patient, it will enter patient image management interface directly, as below picture shows:

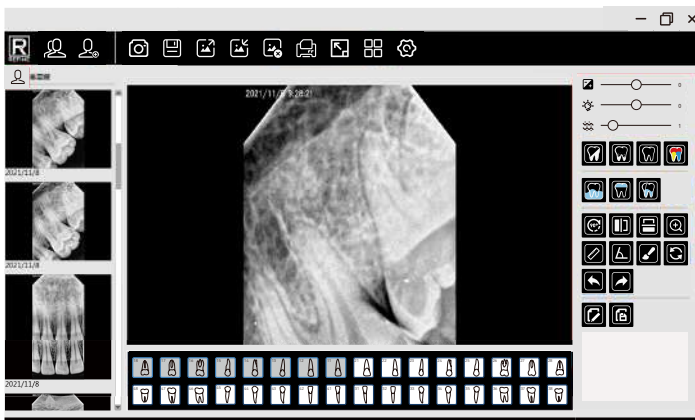

5.2.3 Shooting images

Note: Please select the calibration file before shooting to improve the image quality when first time install the software. Installation method as following:

Step 1: Plug in the USB into the device and connect the sensor.

Step 2: Click, then click "Import calibration file".

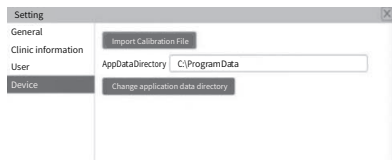

Step 3: Find the file called "Calibration File" in the USB flash disk to import all three calibration files.



5.2.4 Report printing

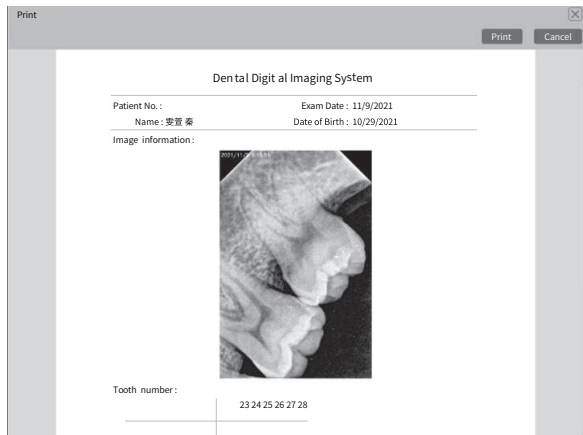

5.2.5 Setting

The 'Setting' dialog box has a sidebar with 'General' selected. The main area contains three settings: 'Language' with a dropdown menu showing 'English', 'Daw Color' with a red color bar and a dropdown arrow, and 'Brush Size' with a dropdown menu showing '2'. An 'Exit' button is located at the bottom right.

General setting to choose language, draw color and brush size

The 'Setting' dialog box has 'Clinic information' selected in the sidebar. The main area contains three text input fields: 'Name', 'Phone', and 'Address'. Below the 'Address' field is a 'Save' button. An 'Exit' button is at the bottom right.

Clinic information to input clinic information which will be showed on the report

The 'Setting' dialog box has 'User' selected in the sidebar. At the top, there is a checked checkbox 'Enable user name and password'. Below are two sections: 'Modify User Name' with 'Current User Name' and 'New User Name' text boxes and a 'Modify User Name' button; and 'Modify Password' with 'Current Password', 'New Password', and 'Confirm New Password' text boxes and a 'Modify Password' button. An 'Exit' button is at the bottom right.

User page to change user name, new password.

The 'Setting' dialog box has 'Device' selected in the sidebar. The main area contains three dropdown menus: 'Sensor Type' (set to 'R1'), 'Trigger Mode' (set to 'DC'), and 'Trigger Threshold' (set to '100uGy'). Below these are an 'Import Calibration File' button, an 'AppData Directory' text box containing 'C:\ProgramData\RF\DentalSensor', and a 'Change application data directory' button. An 'Exit' button is at the bottom right.

Device page to choose the sensor type, trigger mode, trigger threshold, data directory.

6 Trouble shooting

Fault	Possible cause and solution
No image showed after X-ray exposure	Inspect the connection of sensor and computer
	Confirm whether the sensor is at the right direction towards the X-ray
	Change the data of trigger threshold in the "Setting-Device"
	Restart the software
	Re-insert the sensor
Image dark with stripes	Increase exposure time
	Choose the right sensor type, trigger mode and trigger threshold
	Tube voltage from the X-ray machine too low(<60kVrms), check the X-ray machine
	The X-ray machine too far away from the patient
	Inspect the contrast and brightness of the computer
Image not clear	The patient moved when exposure
	X-ray machine not stable
Image is white	The sensor not at the right direction towards the X-ray
	The X-ray dose not enough
	The sensor not connected correctly
	X-ray machine not stable

7 Cleaning and disinfection

7.1 To further eliminate the latent danger of cross infection, in addition to using disposable protective sheath, the sensor and the front 40cm cable should be cleaned and disinfected before each patient is replaced for photographing. The recommended disinfectant for cleaning and decontamination is 70% isopropanol. It's recommended to use a cloth sprayed with aldehyde-free disinfectant to wipe and disinfect the surface.

7.2 Unavailable cleaning and disinfection methods

7.2.1 Do not use hard tools to clean for avoiding abrasion.

7.2.2 The following disinfectants are forbidden: trichloroethylene, dichloroethylene, ammonium hydrochloride, chlorinated hydrocarbons and aromatic hydrocarbons, dichloroethane, methylene chloride and methyl ketone.

7.2.3 Do not spray the disinfectant directly on the X-ray sensor.

8 Storage and transportation

8.1 Storage

8.1.1 This device should be handled with care, away from the source of the earthquake, and should be installed or stored in a cool, dry and ventilated place.

8.1.2 Do not mix it with toxic, corrosive, flammable and explosive materials during storage.

8.1.3 The product should be stored in an environment with a relative humidity of 10%~95%, an atmospheric pressure of 70kPa~106kPa, and a temperature of -10°C ~ +55°C.

8.2 Transportation

8.2.1 During transportation, excessive impact and vibration should be prevented. Handle it with care and avoid inversion.

8.2.2 It should not be mixed with dangerous goods during transportation.

8.2.3 Avoid sunlight, rain or snow during transportation.

9 After service

Since the date of sale, if the device fails to work normally due to quality problems, our company will be responsible for the maintenance with the warranty card. Please refer to the warranty card for the warranty period and scope. This product does not contain self-maintained parts, and the maintenance of this device should be carried out by designated professionals or special technician.

We will not be liable for defects or their consequences if they are likely to be a direct result or actions or modifications by customers or third party.

10 Electromagnetic compatibility

10.1 EMI compliance table

Phenomenon	Compliance	Electromagnetic environment
RF emissions	CISPR 11 Group 1, Class B	Professional healthcare facility environment

10.2 EMS compliance table

10.2.1 Enclosure USB port

Phenomenon	Basic EMC standard	Immunity test levels
		Professional healthcare facility environment
Electrostatic Discharge	IEC 61000-4-2	±8 kV contact, ±2kV, ±4kV, ±8kV, ±15kV air
Radiated RF EM field	IEC 61000-4-3	3V/m ,80MHz-2.7GHz,80% AM at 1kHz
Near fields from RF wireless communications equipment	IEC 61000-4-3	Refer to table "Near fields from RF wireless communications equipment"
Rated power frequency magnetic fields	IEC 61000-4-8	30A/m 50Hz or 60Hz

10.2.2 Near fields from RF wireless communication equipment

Test frequency(MHz)	Band(MHz)	Immunity test levels
		Professional healthcare facility environment
385	380-390	Pulse modulation 18Hz, 27V/m
450	430-470	FM, ±5kHz deviation, 1kHz sine, 28V/m
710	704-787	Pulse modulation 217Hz, 9V/m
745		
780		
810	800-960	Pulse modulation 18Hz, 18V/m
870		
930		
1720	1700-1990	Pulse modulation 217Hz, 28V/m
1845		
1970		
2450	2400-2570	Pulse modulation 217Hz, 18V/m
5240	5100-5800	Pulse modulation 217Hz, 9V/m
5500		
5785		

Recommended separation distances between portable or mobile RF communication device and detector:

Portable RF communications equipment, including antennas, can effect medical electrical equipment. The warning should include a use distance such as "be used no closer than 30 cm (12 inches) to any part of the i-Sensor H1 / i-Sensor H2, including cables by the manufacturer".

10.2.3 Cable provided for EMC

Cable	Recommended length	Shielded/Unshielded	Number	Cable classification
Cable	2.8m	Shieled	1 pc	DC power and SIP/SOP

10.2.4 Electromagnetic Compatibility (EMC)

The dental sensor need special precautions regarding EMC, and should be installed by authorized personnel and follow EMC guidance in the user manual. The product when in use may interfere with portable and mobile RF communication devices such as mobile (cellular) telephones. Electromagnetic interference may result in incorrect operation of the system and a potentially dangerous situation.

The dental sensor should not be stacked with or adjacent to other devices. If inevitable, verify the product.

The dental sensor conforms to the IEC60601-1-2:2014 and EN60601-1-2:2015 standard on both immunity and emissions.

Accessories, transmitters and cables other than those by the user manual or sold together with product may result in increased emissions or decreased immunity of the product.

Notes:

Without the explicit consent of our company, unauthorized changes or modifications to the equipment may cause electromagnetic compatibility problems of this equipment or other equipment.

11 Statement

All rights of modifying the equipment design, product technology or accessories, manual and packaging content at any time are reserved to the manufacturer without further notice.



Guilin Refine Medical Instrument Co., Ltd.

No.8-3, Information Industrial Park, High-Tech Zone,
Qixing District, Guilin, Guangxi, 541004, P.R. China
Tel: +86-773-7796686 Email:refine@refine-med.com
Website: <http://www.refine-med.com>

After service and Warranty Instruction

1 Period validity:

One year's warranty.

2 Range of warranty:

Within the warranty period of validity, we are responsible for any troubles caused by quality problems or products technique and structure.

3 The followings are beyond our warranty:

1) The damage caused by disobeying the operation instruction or lack of the needed condition.

2) The damage caused by unsuitable operation or disassembly without authorization.

3) The damage caused by unadvisable transportation or preservation.

4) There isn't the seal of distributor or the warranty card isn't filled in completed.



Guilin Refine Medical Instrument Co., Ltd.

No.8-3, Information Industrial Park, High-Tech Zone,
Qixing District, Guilin, Guangxi, 541004, P.R. China

Tel: +86-773-7796686 Email: refine@refine-med.com

Website: <http://www.refine-med.com>

After service and Warranty Instruction

Name of Customer	
Address	
Post Code	
Tel	
E-mail	
Purchase Date	
Distributor	
Model	
Product No.	
Handpiece No.	
Production Date	

